

PROFILI RECINZIONI - FENCES PROFILES

PROFILO 30 PER RETE FILO Ø 3,8 - PROFILE 30 FOR NET-WIRE Ø 3,8

85
45

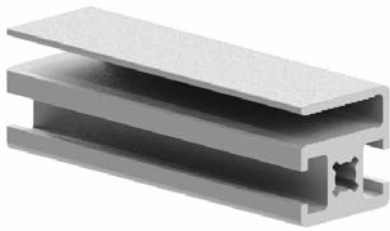

CODICE CODE	MOMENTO D'INERZIA MOMENT OF INERTIA		MODULO DI RESISTENZA SECTION MODULUS		SEZIONE SECTION	PESO WEIGHT
	lx cm ⁴	ly cm ⁴	wx cm ³	wy cm ³	mm ²	kg/m
084.104.001	2,77	3,79	1,84	2,33	398,72	1,08

MATERIALE / MATERIAL: Alluminio anodizzato - Anodized aluminium

Colore naturale - Colour natural

Lunghezza barra 6,040 m - Bar length 6,040 m

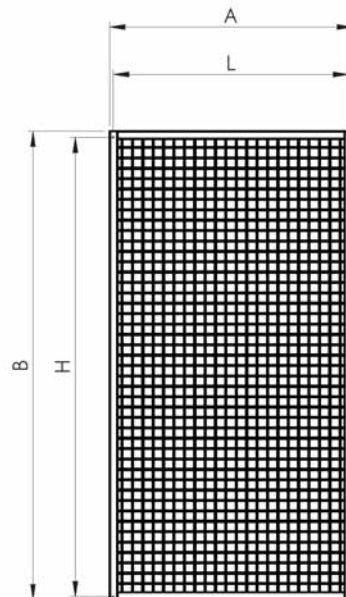
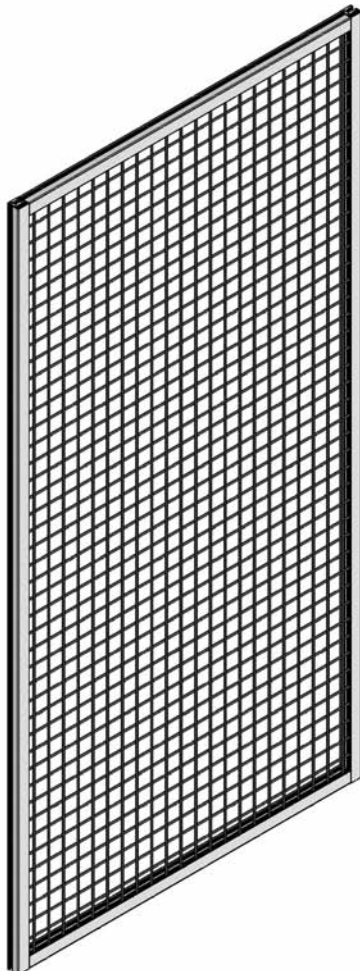
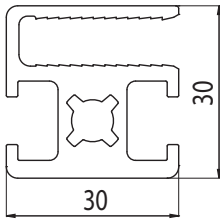

DIMENSIONE RETE - NET DIMENSION

L= A-11
H= B-11

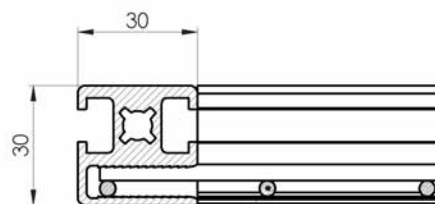

RETE 40x40 FILO Ø 3,8
NET 40x40 WIRE Ø 3,8

PROFILI RECINZIONI - FENCES PROFILES

PROFILO 45X45 - PROFILE 45x45

85
45

NEW

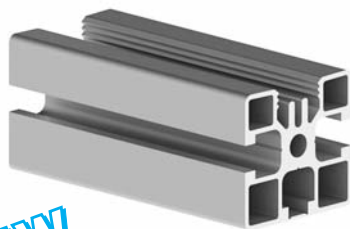

CODICE CODE	MOMENTO D'INERZIA MOMENT OF INERTIA		MODULO DI RESISTENZA SECTION MODULUS		SEZIONE SECTION	PESO WEIGHT
	lx cm ⁴	ly cm ⁴	wx cm ³	wy cm ³	mm ²	kg/m
084.101.061	9,02	10,38	4	4,6	597,66	1,62
084.101.062	0,11	1,65	0,4	2,04	116,5	0,32

MATERIALE / MATERIAL: Alluminio anodizzato - Anodized aluminium

Colore naturale - Colour natural

Lunghezza barra 6,040 m - Bar length 6,040 m

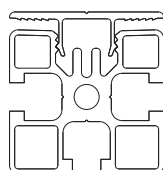
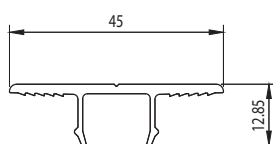
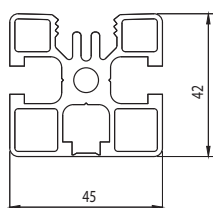

Adatto per pannelli spessore 1 - 3 - 5 mm
Suitable for panels 1 - 3 - 5 mm tickness

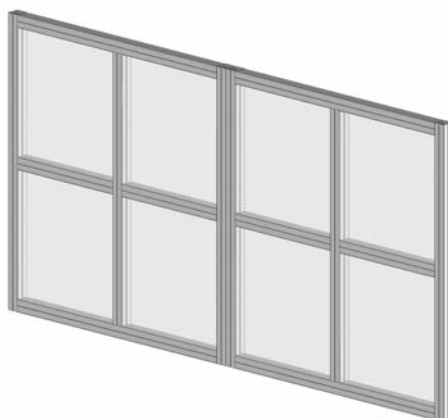
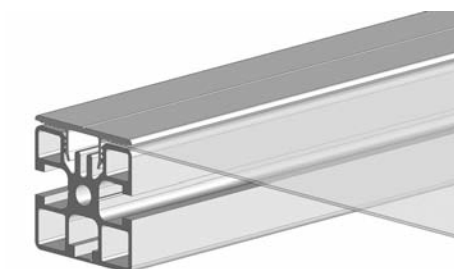
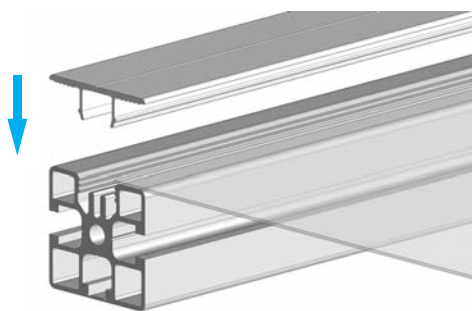

PROFILI RECINZIONI - FENCES PROFILES

PROFILO 30X50 - PROFILE 30x50

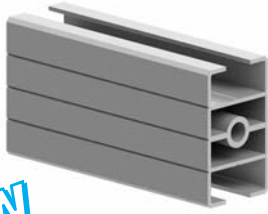

NEW

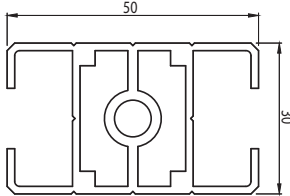

CODICE CODE	MOMENTO D'INERZIA MOMENT OF INERTIA		MODULO DI RESISTENZA SECTION MODULUS		SEZIONE SECTION	PESO WEIGHT
	lx cm ⁴	ly cm ⁴	wx cm ³	wy cm ³	mm ²	kg/m
084.112.001	6,62	4,25	2,65	2,83	360,31	0,97

MATERIALE / MATERIAL: Alluminio anodizzato - *Anodized aluminium*

Colore naturale - *Colour natural*

Lunghezza barra 6,040 m - *Bar length 6,040 m*

PROFILO 50X50 - PROFILE 50x50

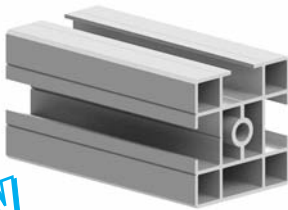

NEW

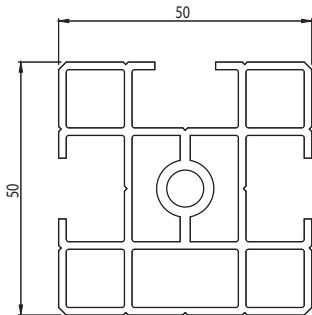

CODICE CODE	MOMENTO D'INERZIA MOMENT OF INERTIA		MODULO DI RESISTENZA SECTION MODULUS		SEZIONE SECTION	PESO WEIGHT
	lx cm ⁴	ly cm ⁴	wx cm ³	wy cm ³	mm ²	kg/m
084.112.002	14,44	13,31	5,78	5,32	582,38	1,57

MATERIALE / MATERIAL: Alluminio anodizzato - *Anodized aluminium*

Colore naturale - *Colour natural*

Lunghezza barra 6,040 m - *Bar length 6,040 m*

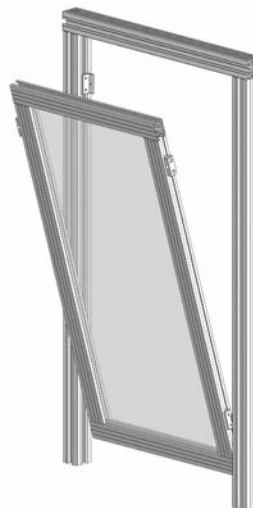
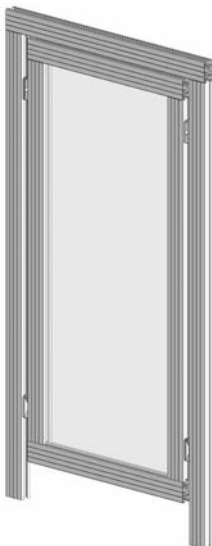

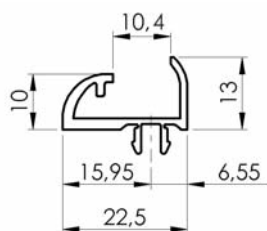
PROFILI RECINZIONI - FENCES PROFILES**PROFILO CORNICE 22,5 - FRAME PROFILE 22,5**65
30

CODICE CODE	DESCRIZIONE DESCRIPTION	PESO WEIGHT
		kg/m
084.100.008	Profilo cornice 22,5 da abbinare al profilo 22,5 x 22,5 Frame profile 22,5 suitable for profile 22,5 x 22,5	0,26

MATERIALE / MATERIAL: Alluminio anodizzato - Anodized aluminium

Colore naturale - Colour natural

Lunghezza barra 6,040 m - Bar length 6,040 m

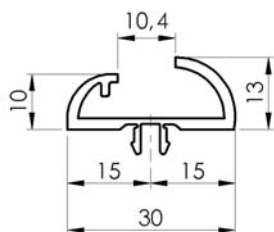
PROFILO CORNICE 30 - FRAME PROFILE 3065
30

CODICE CODE	DESCRIZIONE DESCRIPTION	PESO WEIGHT
		kg/m
084.100.009	Profilo cornice 30 da abbinare al profilo 30 x 30 Frame profile 30 suitable for profile 30 x 30	0,35

MATERIALE / MATERIAL: Alluminio anodizzato - Anodized aluminium

Colore naturale - Colour natural

Lunghezza barra 6,040 m - Bar length 6,040 m

SISTEMI DI MONTAGGIO - ASSEMBLY SYSTEMS

